

A Curved Bowl from a Board

This plan is to turn a bowl with curved sides from a 250 mm by 20 mm board. Three rings of wood are cut from the board and then glued to form the rough bowl. Then that is turned and finished on the lathe.

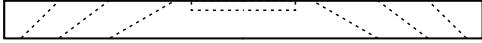

This drawing is to help you understand how the board will be cut.

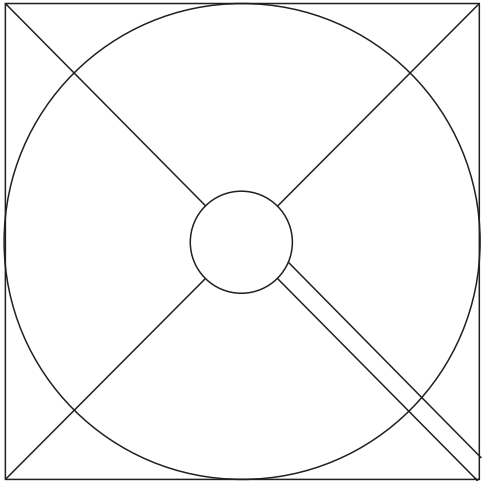

Mark the board on both sides with corner-to-corner lines to find the centre. Add a second line 10 mm away from one arm of the X and the same side of the same arm on the other side. This line will assist with alignment when gluing the parts later.

Drill a 54 mm diameter hole 5 mm into the wood on the side that is to be the bottom of the bowl.

Cut the wood to be round on the bandsaw.

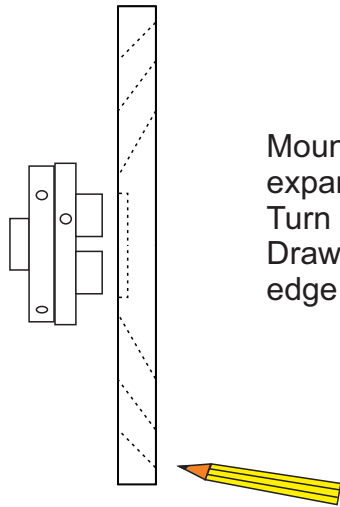

Mount the wood on a chuck used with the jaws in expansion mode.

Turn the outside edge to be perfectly round.

Draw a circular line on the face 8mm in from the edge.

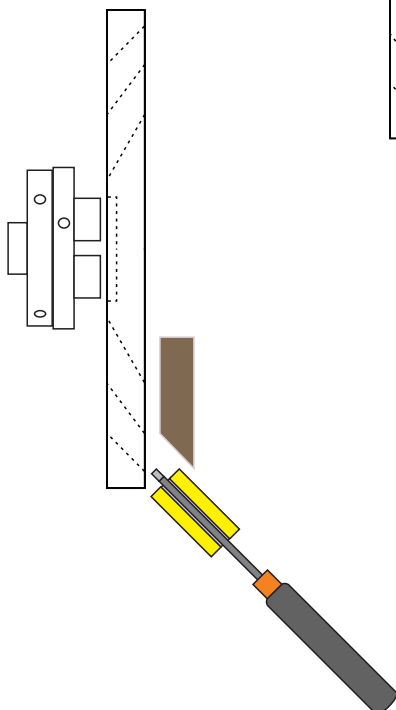

For these sloping cuts at an exact angle it is helpful to have your chisel held in a Parting Tool Support (See <https://sawg.org.nz/tipsnjigs/> and page 4 of this plan). The angle of the cut will depend on the thickness of your parting tool (see page 3 of this plan). Make angle templates for each of the cuts you plan to make. Use an angle template to set the parting tool support to the exact angle required for the first cut. Each cut must be on the inner, right hand side, of the marked line. Cut the outer ring off the board.

A Curved Bowl from a Board p2

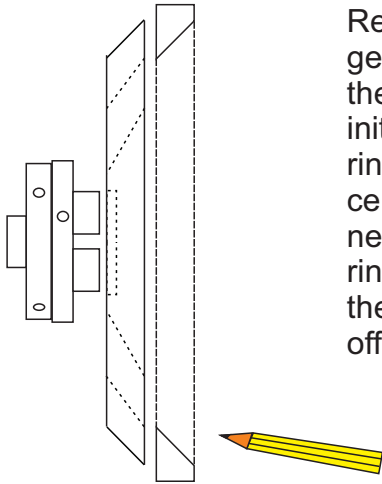

Remove the chuck, with the board still attached, from the lathe to get the ring away from the lathe. Put the chuck and board back on the lathe. On the ring, continue the crossed lines drawn in the initial markup onto the sloping inner face of each ring. Hold the ring of wood to the board on the chuck. Use the drawn lines to centre it accurately. Use the inner edge of the ring to mark the next cut line on the board. Or measure the inner diameter of the ring you have cut off and mark that on the remaining board. Reset the parting tool support to the next angle and part the second ring off. Repeat this process for the third ring.

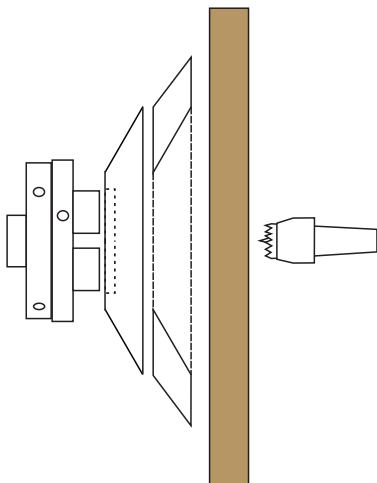
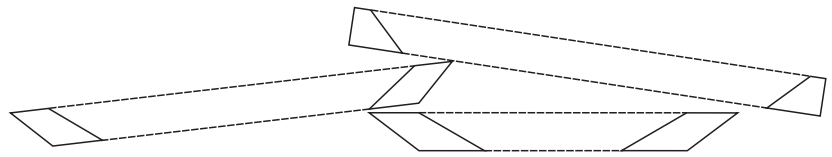

You now have the inner, smallest part of the bowl still on the chuck and three rings of wood. Take the smallest of the three cut rings and glue it, with perfect alignment, to the small part on the chuck. Bring up a board and the tailstock to press it into place until the glue is set enough to add each of the next rings. When the glue is set you can shape the bowl. Cut, sand and finish all the inside and as much as possible of the outside.

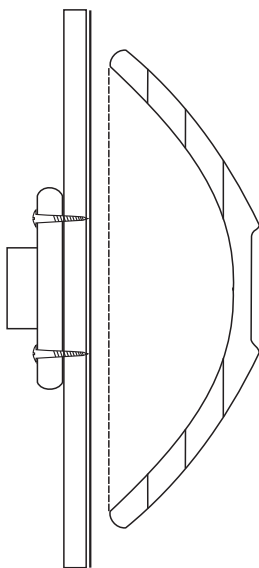
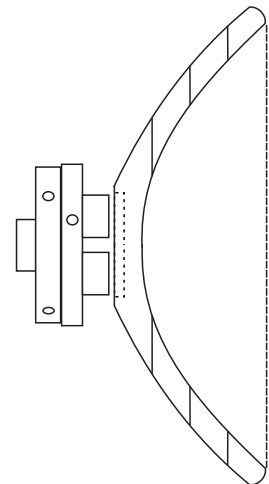

Take the bowl off the chuck, turn it over and remount it on a vacuum chuck, Cole jaws or other method. Cut, sand and finish the foot of the bowl.

Curved Bowl from a Board Cutting Options

Before putting wood on the lathe it is worth a moment to understand the way this Bowl from a Board cutting process works. The plan is to use a parting tool to cut along the right-hand (inner) side of the 35° line in the drawing below. Then, use the inner diameter (A) of the ring of wood you have parted off to determine the outer diameter (B) of the next ring. A and B need to be the same diameter for the rings of wood to match when glued together. If a 10 mm thick bowl is to be cut then a 1 mm parting tool is needed for a 20 mm thick board or a 5 mm parting tool can be used if a 25 mm thick board is used. Or the angle of the first cut is changed as shown in the three lower drawings. If you have only a thinner board then the angle of the first cut needs to be changed to get a smaller diameter to mark for the second cut.

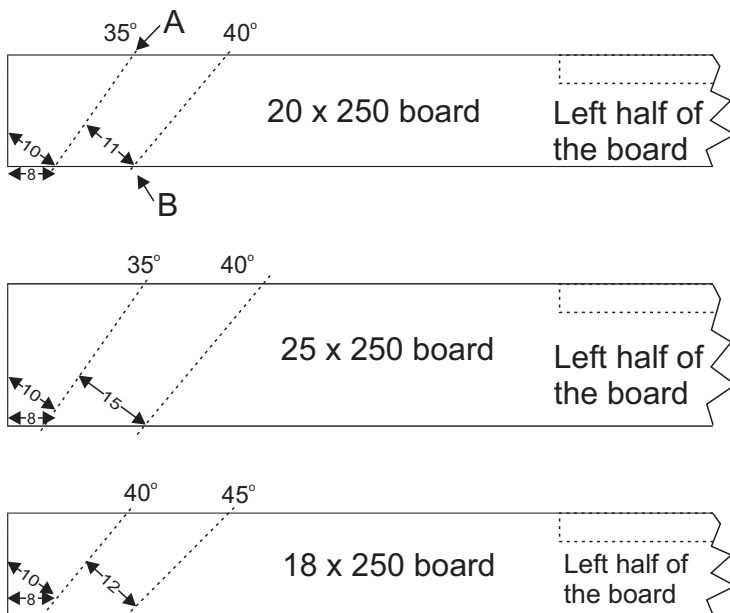

The measurements shown below are for a board 250 mm in diameter and 20 mm thick to show what parting tool you need to use - shifting the cut line is not an option. Each parting cut is to the right of the marked line. The angles are a clockwise rotation from vertical.

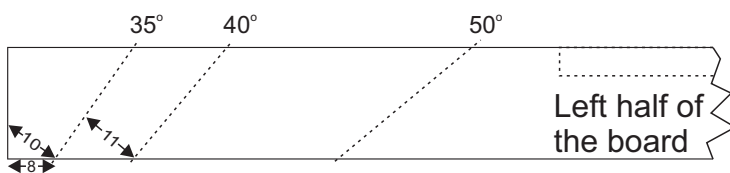

The first cut allows for a 4 segment bowl with a thickness of 10 mm but that can be continued only if a 1 mm parting tool is used for the first cut.

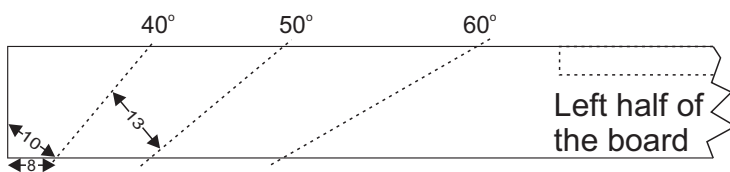

The first cut allows for a bowl with a thickness of 10 mm. That can be continued if a 3 mm parting tool is used for the first cut.

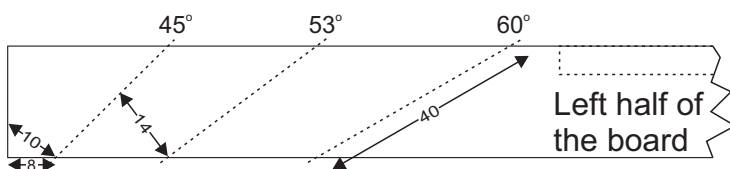

The first cut allows for a bowl with a thickness of 10 mm. That can be continued if a 4 mm parting tool is used. The last cut will be 40 mm long.

Parting Tool Support

There are occasions in woodturning when it is desirable to have your parting tool, or some other tool, pushed forward in a straight and controlled manner. The support shown here is intended for that style of work. This support may be made of steel or wood and may be adjustable for different thicknesses and heights of chisel.

If you think you will use only one thickness of chisel then all parts can be firmly welded or glued together. For options for future use with other chisels, one side of the upper part may be securely attached. Then the other side can be moved and locked in place to accommodate chisels of varying thickness.

No dimensions or construction methods are shown as there are too many options to be considered.

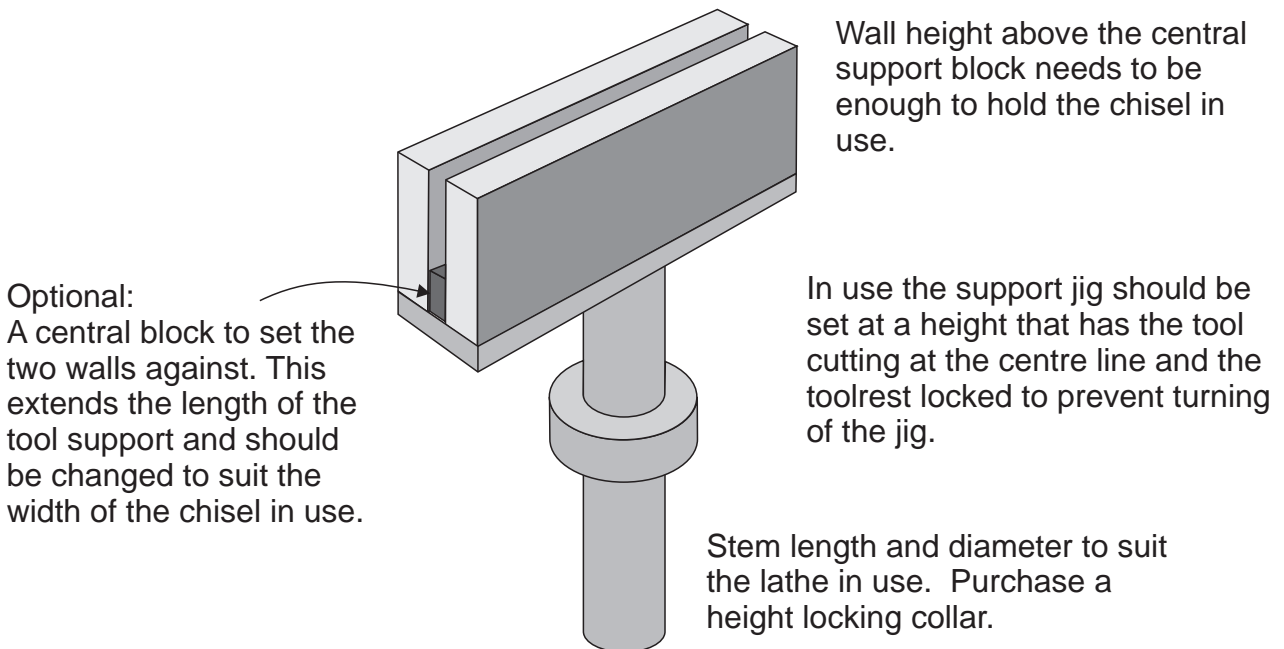

If necessary, ensure that the parting tool is shaped to fit a curving cut.

